



LYCEUM

INTERNATIONAL SCHOOLS

First Examination – October 2019

Subject : Information Communication Technology - I

80	E	I
----	---	---

 Class : 10X (National)8.....
 Duration : 1 hour Date : 2019/10/01
 Candidate's name : Shezmeena usman Admission no : E101795

Note :

- Answer all the questions.
- In each of the questions 1 to 40, pick one of the alternative (1), (2), (3) and (4) which you consider as correct or most appropriate.
- Mark a cross (x) on the number corresponding to your choice in the answer sheet provided.

- (1) The basic architecture of a computer was developed by
 (1) John Von Neumann. (2) Charles Babbage.
 (3) Blaise Pascal. (4) Garden Moore.
- (2) A hard disk is divided into tracks which are further subdivided into
 (1) clusters. (2) sectors. (3) vectors. (4) heads.
- (3) The component that contains the lowest data speed and the smallest data storage capacity is
 (1) Flash memory and cache memory. (2) register memory and cache memory.
 (3) Hard Disk and Magnetic Tape. (4) Magnetic Tape and Register Memory.
- (4) The binary equivalent of 187_{10} is
 (1) 10111011_2 (2) 11011101_2 (3) 10111101_2 (4) 10111100_2
- (5) What is the least significant digit and the most significant digit of 358.70 respectively?
 (1) 3,0 (2) 3,7 (3) 7,3 (4) 0,3
- (6) Which of the following is the octal equivalent of $5AD_{16}$?
 (1) 2655_8 (2) 6285_8 (3) 6266_8 (4) 2654_8
- (7) The word 'COMP' can be encoded in ASCII as follows. Select the correct ASCII coding for 'BNLR'.
 (1) 1000100, 1001110, 1001100, 1010010
 (2) ~~1000101, 1001110, 1001100, 1010010~~
 (3) ~~1000100, 1001110, 1011100, 1010010~~
 (4) 1000100, 1001110, 1001100, 1011110

C	O	M	P
1000011	1001111	1001101	1010000

8. Which of the following lists shows the descending order of 0011101_2 , 171_8 , 350_{10} , AEA_{16} ?
- (1) AEA_{16} , 0011101_2 , 171_8 , 350_{10} (2) 350_{10} , 0011101_2 , 171_8 , AEA_{16}
 (3) AEA_{16} , 350_{10} , 171_8 , 0011101_2 (4) AEA_{16} , 171_8 , 350_{10} , 0011101_2

9. A 2 megabyte contains
- (1) 2^9 Kilobytes. (2) 2^{21} bytes. (3) 10^6 bytes. (4) 2^{20} bits.

10. Consider the following logic circuit?

- (1) $\overline{(A+B)} \cdot \overline{[(B+C) \cdot (CD)]}$
 (2) $\overline{(A \cdot B) + [(B+C) + (CD)]}$
 (3) $\overline{(A \cdot B) + [(B \cdot C) + (C+D)]}$
 (4) $\overline{(A+B) \cdot [(B+C) \cdot (C+D)]}$

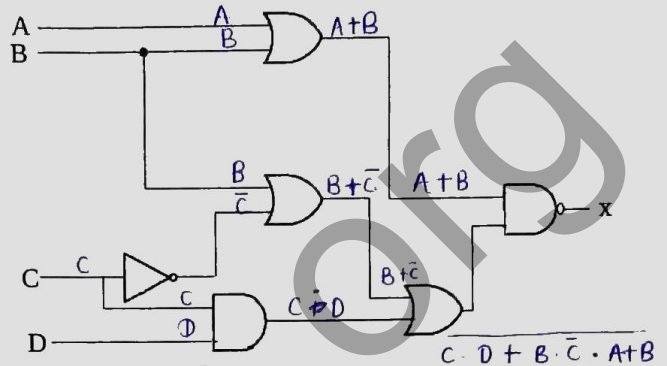

11. If $A = 0$ and $B = 1$ then find the value of W, X, Y and Z respectively.

- (1) 1,0,0,1
 (2) 1,0,0,0
 (3) 1,0,1,0
 (4) 1,1,0,0

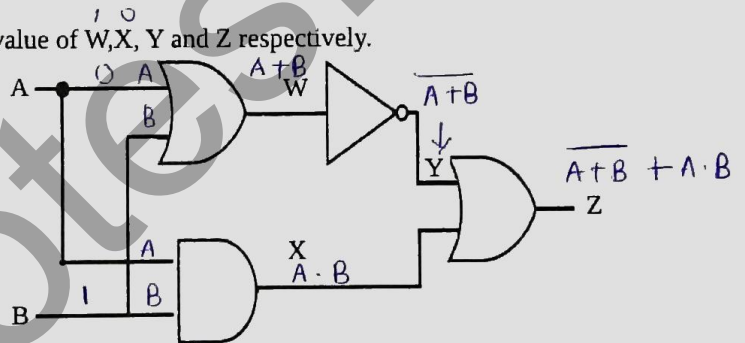

12. The table operation in the cell A is known as _____ and its reverse operation is known as _____. The correct words for the blanks are



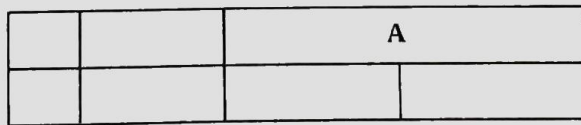

- (1) merge, split
 (2) split, merge
 (3) join, split
 (4) divide, merge



13. Select the correct statement on character and line spacing option in a word processing applicationn.

- (1) Line spacing determines the amount of horizontal space between the lines of the text in a paragraph.
 (2) Character spacing determines the amount of vertical space between the lines of text in a paragraph.
 (3) You can not change the spacing before and after selected paragraphs.
 (4) If you increase amount of character spacing all over the document number of lines may be increased.

14. Which of the following correctly identifies tools A , B , C and D respectively ?

A	B	C	D
			

- (1) Find & Replace, Format Paintbrush, Undo, Open
- (2) Find & Replace, Fill Colour, Redo, Open File
- (3) Search, Paint brush, Undo, Open File
- (4) Search, Paint brush, Redo, Open Document

15. Consider the following statements,

- A - Clipart can be inserted in to e-presentation.
- B - Slide background can be included in different colors, shapes and pictures.
- C - Only shapes on a slide can be animated out of text, shapes and images.

Which of the above statement/s is /are true?

- (1) A only.
- (2) B only.
- (3) A and B only.
- (4) B and C only.

16. Consider the following statements related to presentation software:

- A - Pressing the key P within a slide show will display the previous slide.
- B - Using CTRL + N key combination will insert a new slide.
- C - Slide sorter view can be used to view more than slide in the screen.

Which of the above statement(s) is/are correct ?

- (1) A and B only.
- (2) A and C only.
- (3) B and C only.
- (4) All A, B and C.

17. Consider the following statement.

"Execution of a program is a single process. Therefore before execution of a program the whole program is divided into small tasks within the computer?"

Which type of management in the operating system performed the above task ?

- (1) Memory Management
- (2) Device Management
- (3) File Management
- (4) Process Management

18. A and B pictures show two different file accessing methods. They are

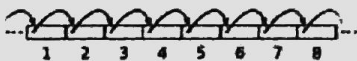

A



B

- (1) Random access , Direct access
- (2) Random access , Sequential access
- (3) Direct access , Random access
- (4) Sequential access , Random access.

Questions 19 and 20 are based on the spreadsheet segment shown below.

	A	B	C	D	E
1	A	B	A*B	(A*B)^2	(A*B)+B
2	7	10	70	4900	80
3	9		90	8100	100
4	4		40	1600	50
5	8		80	6400	90
6					
7					

19. Which of the following will be written in cell C5, if the formula in C2 is copied to C5?
 (1) =A5 * B2 (2) =A5* \$B\$2 (3) =A5 *2\$B\$ (4) =\$B2* \$A\$5\$
20. What is the formula that has to be written in cell E2 to get the value of 80?
 (1) =(A2*B2)+\$B\$2 (2) =(2A*B2)+\$A\$2
 (3) =(A3*D2)+\$B\$2 (4) =D2+\$B\$2
21. What is the result for =5^2+1+8/2*2 in spreadsheet software?
 (1) 28 (2) 34 (3) 127 (4) 133
22. Which of the following statements is incorrect, if A is 20 and B is 35?
 (1) NOT(A<B) evaluate to True
 (2) NOT(A>B) AND (A < B) evaluate to False.
 (3) (A<B) OR NOT(B>=A) evaluate to True.
 (4) NOT(B>=A) evaluate to Flase.
23. Ravi assumes that the following concepts are related to images and its size.
 A) Image capacity is determined by number of pixels in the columns and rows.
 B) bpp (bit per pixels) is essential to calculate size an image file.
 C) Using 8 bits 512 colors could be represented.

Which of the above statements are correct ?

- (1) A and B only (2) A and C only (3) B and C only (4) All A, B and C.
24. Which of the following is the correct form of a URL ?
 (1) http://www.docnets.lk/exam/ (2) http://www.docnets.lk/exam/
 (3) html://www.docnets.lk/exam/ (4) http:\\www.docnets.lk\\exam\\

• Use the following tables to answer questions 25 & 26.

Book Table

Book_ID	Book Name	Borrowed
B001	Manuthapaya	True
B002	Himagiriarana	False
B003	Gamperaliya	True

Borrowing Table

Date	Book ID	S_ID
2017/02/24	B002	S003
2017/03/01	B001	S002
2017/03/10	B002	S002

Student Table

S_ID	Student Name
S001	Gimhani
S002	Kusal
S003	Vishwa

25. Which of the following fields are suitable as primary key ?
- (1) Book Table - Book_ID and Borrowing Table - S_ID
 - (2) Book Table - Book_ID and Student Table - S_ID
 - (3) Borrowing Table - Book_ID and Borrowing Table - S_ID
 - (4) Student Table - S_ID and Borrowing Table - S_ID
26. Which of the following is the number of fields and records in borrowing table respectively ?
- (1) 4 and 3
 - (2) 3 and 4
 - (3) 2 and 3
 - (4) 3 and 2

27. Consider the following HTML segment:

```
<table border='2'>
  <tr> <th>Name</th><th>Address</th></tr>
  <tr> <td>Kamil</td><td>Kandy</td> </tr>
  <tr> <td rowspan="2">Ganesh</td><td>Kegalle</td> </tr>
  <tr> <td>Colombo</td></tr>
</table>
```

The output of the above HTML code segment would be:

(i)

(ii)

(iii)

(iv)

Name	Address
Kamil	Kandy
Ganesh	Kegalle
	Colombo

Name	Address
Kamil	Kandy
	Kegalle
Ganesh	Colombo

Name	Address
Kamil	Kandy
	Kegalle
Ganesh	Colombo

Name	Address
Kamil	Kandy
	Kegalle
Ganesh	Colombo

28. Consider the following scenario.

The department of registration issues an ID card to each citizen for identification.

Which relationship of the following matches the above scenario, that's the relationship between the ID card and the person ?

- (1) One to one
- (2) One to many
- (3) Many to many
- (4) No relationship

29. Which of the following is true about web authoring tools ?

- (1) FrontPage and Kompozer are open source web authoring tools.
- (2) All web authoring tools are open source.
- (3) They help to prepare HTML document automatically.
- (4) Ckeditor is a proprietary web authoring tool.

30. Select the Pascal valid identifier given below.
 (1) Average marks (2) First-Name (3) First@name (4) First_Name
31. Consider the following statements.
- The newly developed system is used in a selected area is called -----A-----
 - Modules are combined and tested is called -----B-----
 - Both the existing system and the new system which are used for a certain period is called -----C-----

The correct terms to fill the blanks A, B, C in the above three statements are respectively

- (1) Paralled development, Integration, Testing, Pilot deployment
 - (2) Pilot deployment, Integration, Testing, Parallel deployment
 - (3) Integration, Testing, Pilot deployment, Parallel deployment
 - (4) Pilot deployment, Integration, Testing, phased deployment
32. Which one of the following statements is incorrect regarding a variable used in a computer program ?
- (1) A variable has a name.
 - (2) A variable refers to one or more memory locations.
 - (3) A variable has a data type.
 - (4) The value of a variable remains changed.
33. Which of the following is/are scripting languages ?
- A PHP
 - B Pascal
 - C JavaScript
- (1) A,B only (2) A,C only (3) B,C only (4) All are correct
34. At the end of the testing period, a testing is carried out with the users of the system and the user is allowed to use the system. Either the user approves or request for more improvement. This testing method is called
- (1) Unit Testing.
 - (2) Overall Testing.
 - (3) System Testing.
 - (4) Acceptance Testing.

Questions 35 to 36 are based on the following pseudo code. This calculates the total of odd numbers between 0 and 10.

```
Tot = 0
No = 1
While No < 10
Tot = Tot + No
No = No + 2
End while
```

35. How many times will the while loop be executed ?

- (1) 5 (2) 6 (3) 10 (4) 11

36. What is the value of "No" after the execution of this pseudo code ?

- (1) 3 (2) 7 (3) 9 (4) 11

37. What is the output of the given pascal statement ?

* Write $(26 + 12/2 - 8 + 20 \text{ div } 2 \text{ Mod } 4)$

- (1) 03 (2) 45 (3) 13 (4) 26

38.

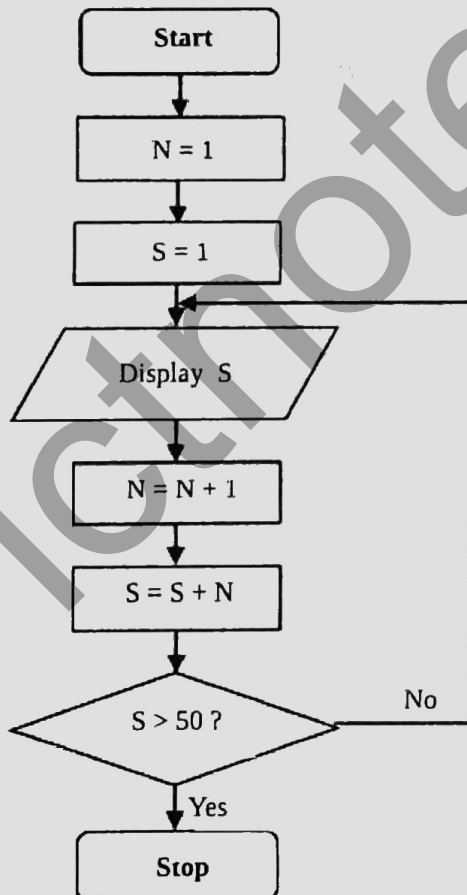

What are first three numbers displayed by this flowchart ?

- (1) 1, 4, 9
 (2) 1, 3, 6
 (3) 1, 3, 5
 (4) 2, 4, 6

N	S
1	1
2	3
3	6

39. Which of the following statements is incorrect about harmful software and resultant damages?

- (1) Spam is unauthorized e mail.
- (2) Adware misdirects users to different web sites.
- ~~(3)~~ Bots are used to collect personal information.
- ~~(4)~~ Trojan horse does spread by itself.

40. Consider the following statements about Cyber crime :

- A - using social media
- B - uploading other's images without permission.
- C - publish information which harm a person's reputation

Which of the above belong to cybercrime ?

- (1) A and B only.
- (2) B and C only.
- (3) A and C only.
- (4) A , B and C only.

[Total = 40 marks]

END

Examination : First Semester

Date : 2019/11/11

Name : Shreemeda

Subject : ICT

Class : ICXB

~~30~~ + 3 = 33
~~40~~

Q.	a	b	c	d
1				X
2		X		
3		X		X
4		X		
5			X	
6		X		
7		X		
8			X	
9		X		X
10		X		

Q.	a	b	c	d
11		X		
12		X		
13			X	
14		X		X
15			X	
16		X		
17		X		
18			X	
19		X		
20		X		

Q.	a	b	c	d
21		X		
22		X		
23		X		
24		X		
25			X	
26		X		
27		X		
28		X		
29		X		
30		X		

Q.	a	b	c	d
31		X		
32		X		
33		X		
34		X		
35		X		
36		X		
37		X		
38		X		
39		X		
40		X		